

METHOD  
COLLECTION

---

# Harrows®

CHAMPIONS OF SOCIAL SPACES    [HARROWS.COM.AU](https://www.harrows.com.au)

**Champions of  
social spaces.**



# Introducing Method

Functional, flexible and inviting, Method is a collection of lounges and accessories that are devised to connect people and compliment any space.

Hushchairs, hard top ottomans and lounges feature an offset leg that serves as a mount-point for a variety of accessories from lighting, side tables to power, allowing limitless functional configurations.







Removable swivel table  
finished with clear  
indoor stain



Non fixed cushions and a  
unique inverted seam

Upholster in any  
fabric



# Limitless Possibilities

The modular square design and offset leg allows each component to be turned 90 degrees in any direction to offer limitless design and layout opportunities.

Method's frame was based on a square grid format with an offset leg on each corner, so each piece can be orientated to create limitless configurations. Power input, a coat rack, an overhead lamp and rotating side tables can be easily connected to any tubular steel leg and changed about effortlessly for different applications.



# 2 Pot Planter System

No need for messy transplanting. Just place the standard nursery pots that your plant comes in directly into the pot liner and add topping for a fully planted look.

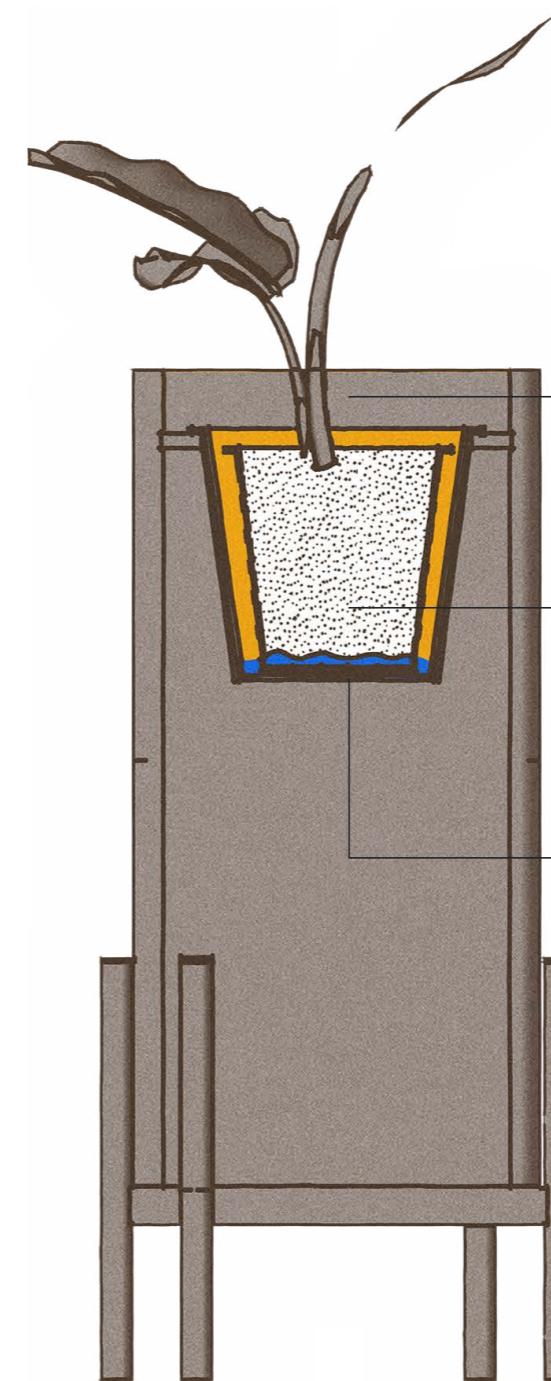

## Fully Planted Look

Liner pots are set down from the outside edge to allow for bark, coconut fiber or topping of choice to be laid around plants to create a fully planted look (fill not included).

## Nursery Pot

Slip standard nursery pots up to 4.5L directly into the watertight pot liner (plants and nursery pots not included).

## Pot Liner

Planters include a watertight pot liner as standard, allowing for easy watering and no drips or mess. Pot Liners have a 215mm opening, tapering to 140mm at the base, and a depth of 190mm.

Accessories can be moved to any leg

Upholstered in fabric of choice

Power outlets can be mounted to any leg

Swivel tables can be mounted any leg

Timber accents stained in colour of choice

Frames powder coated in colour of choice

Offset legs allow for configuration



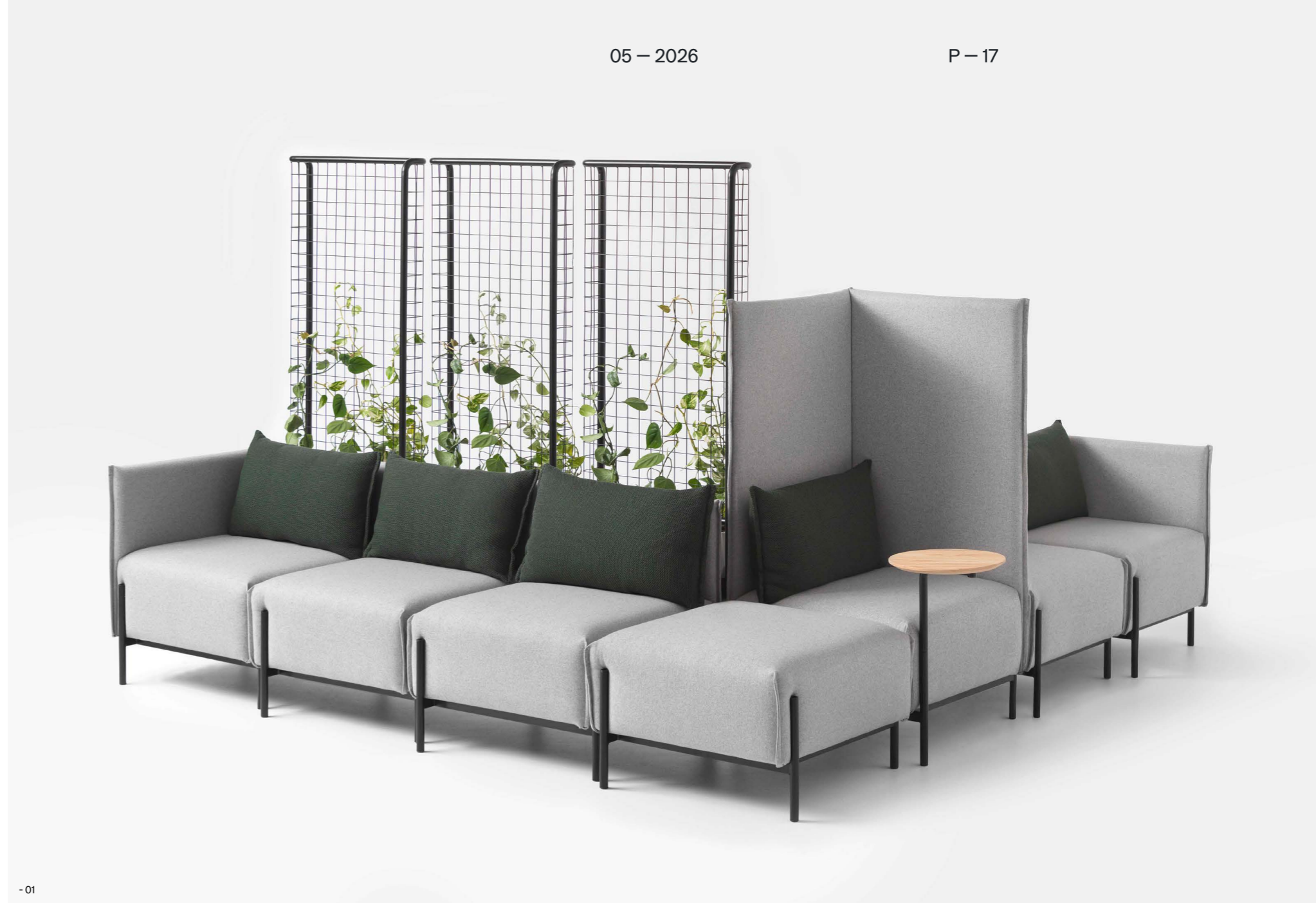

- 01

Key Features

- 01 Complete configurations featuring a combination of lounges, ottomans, planters, backs and side tables.
- 02 Integrate power and side tables.
- 03 Offset leg design.
- 04 Unique inverted seam finish.
- 05 Coat rack accessory.

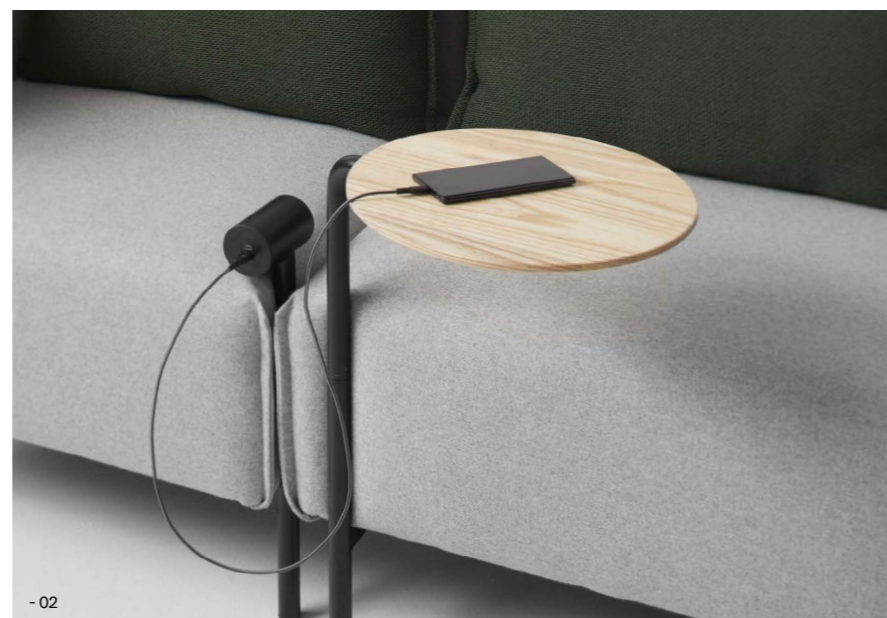

- 02

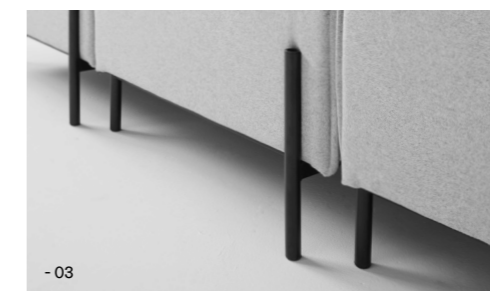

- 03



- 04



- 05

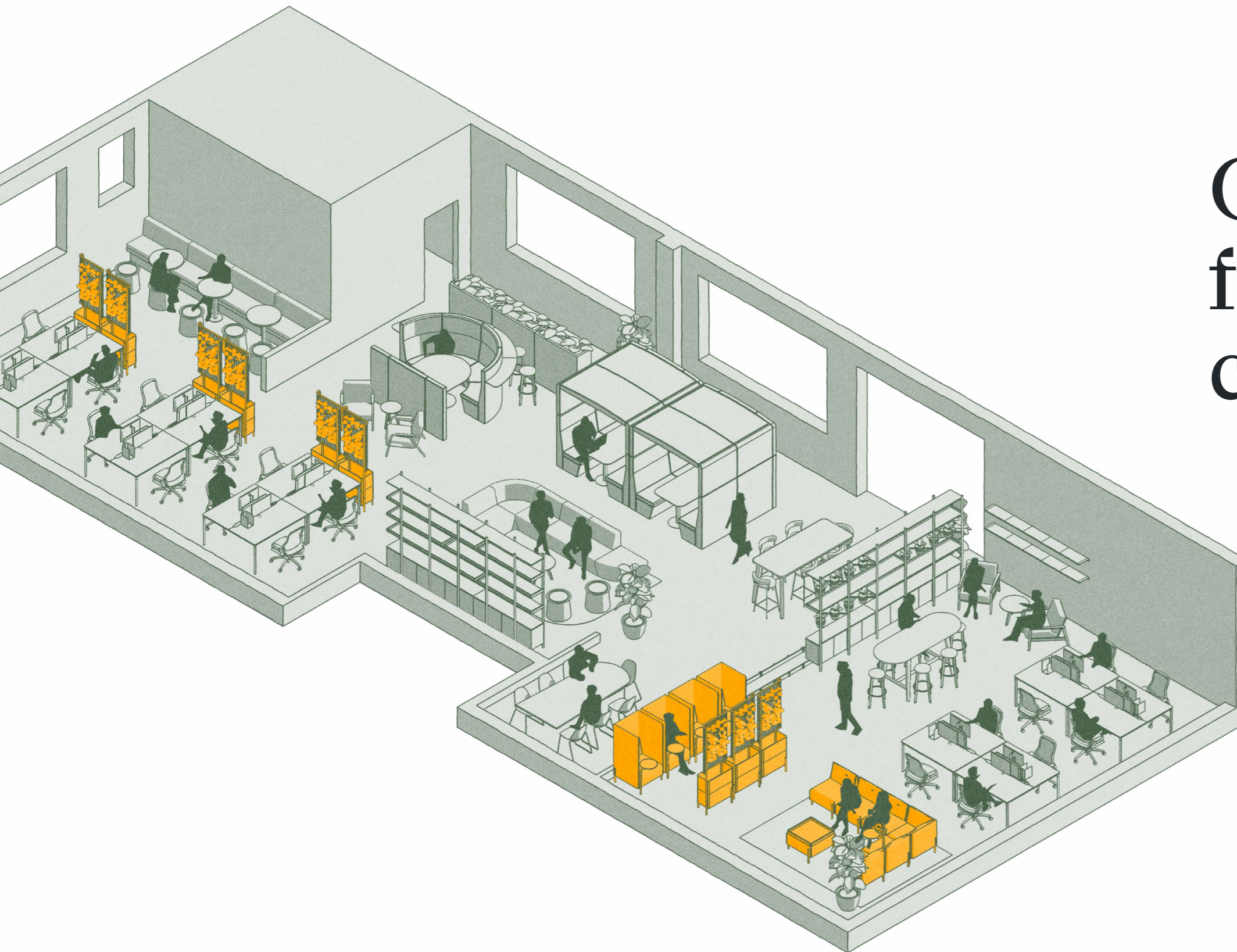

# Crafted for every connection.

## Lounge settings

With a selection of corners and straights, ottomans, coffee tables and lounges, the Method Seating creates an endless configuration of lounge settings to create casual waiting or breakout moments.

## Focus spaces

The Method Hushchair has the same offset leg design meaning it can integrate with the lounge system, or stand alone. Create the perfect breakout pod for the commercial space by upholstering the Method in any fabric and powder coating the frame in any colour.

## Privacy screening

The Method Planter integrates seamlessly with the Method Seating System, or can stand alone. It is available at multiple heights as a planter, and with a screen also. A striking freestanding planter options for creating privacy and bringing biophilia into any setting.

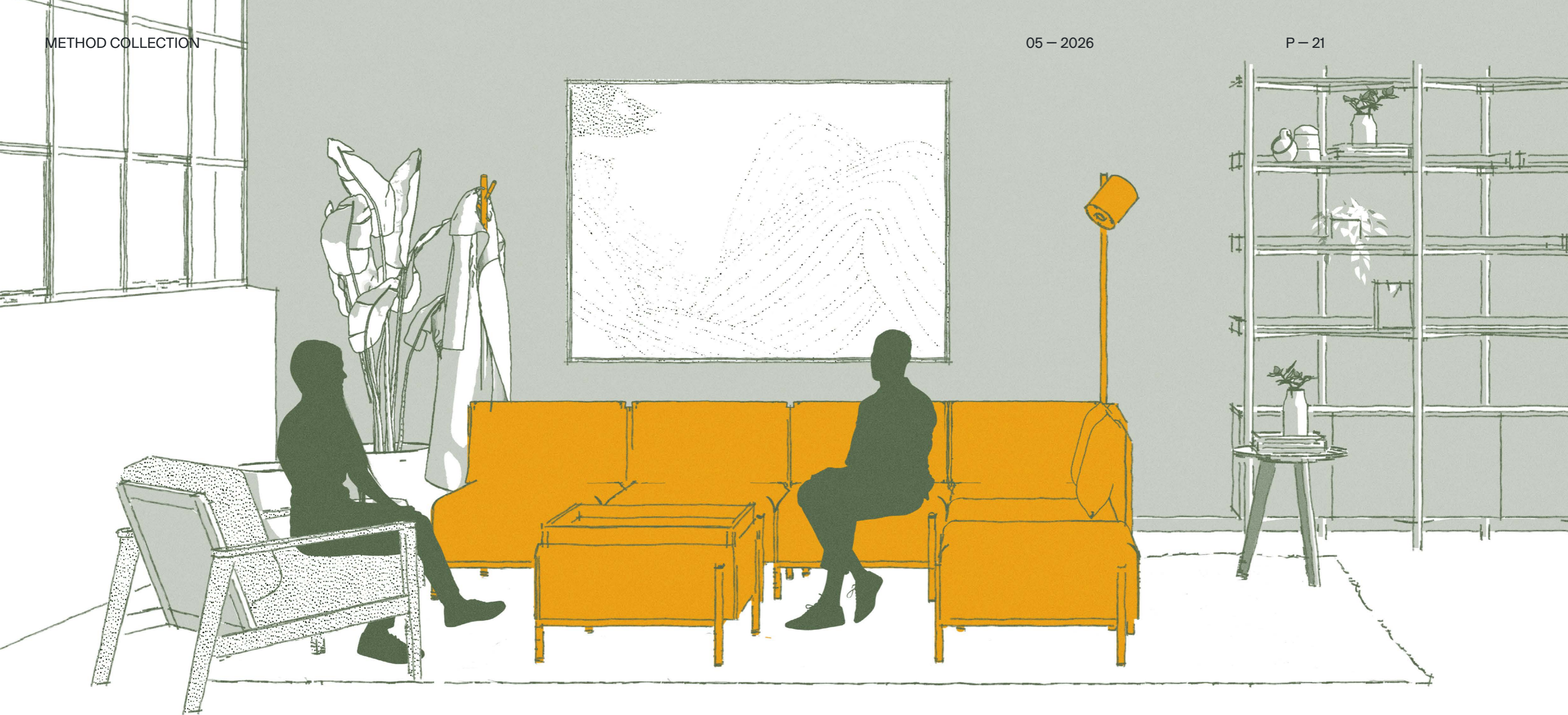

# Designed for designers.

With so many configurations, we understand the importance of being able to visualise the finished product, and provide a full suite of 3D and BIM files for Revit, ArchiCAD and SketchUp.

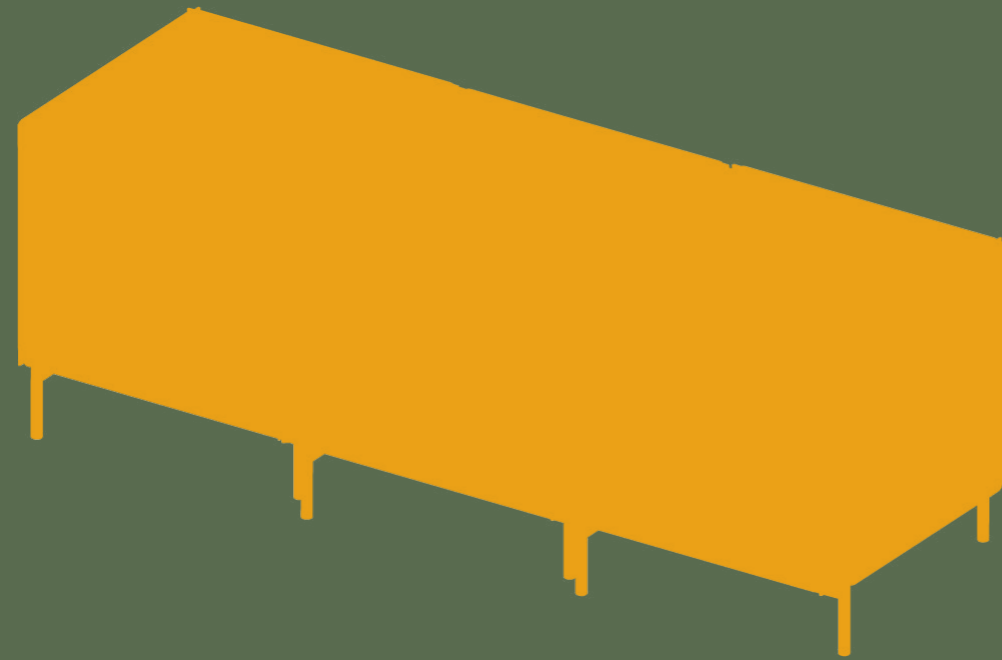

#### Key Features

- 01  
NZ designed, NZ made
- 02  
Timber stained in colour of choice
- 03  
Upholstered in fabric of choice
- 04  
Method collection extension

# Method



A versatile collection of lounges and accessories designed to foster connection and enhance any environment. With its square grid frame and offset legs, Method offers limitless configurations, easily accommodating power inputs, coat racks, lamps, and rotating side tables. Featuring non-fixed cushions and a distinctive inverted seam, Method seamlessly transitions from standalone pieces to collaborative hubs.

<u>Made from</u>	Upholstery over foam on steel frame
<u>Finishes</u>	Upholstered in any fabric Frame powder coated in any colour Timber stained in any colour
<u>Dimensions</u>	720 x 720 Seat 450h Arms 750h Highback 1380h
<u>Application</u>	Indoor use
<u>Warranty</u>	10 year commercial warranty
<u>Lead time</u>	Made to order - 8 to 10 weeks
<u>Origin</u>	New Zealand
<u>Designer</u>	Harrows
<u>Certification</u>	Global GreenTagCert™ GreenRate Level C GreenTagPHD™ PlatinumHEALTH™ & HealthRATE™ Declaration™



#### Key Features

- 01  
NZ designed, NZ made
- 02  
Designed for privacy
- 03  
Upholstered in fabric of choice
- 04  
Method collection extension

# Method



Method Hushchair, an innovative addition to the Method Seating system. Built on a square grid format with offset legs, it seamlessly integrates with the broader Method range for ultimate adaptability. Easily connect power inputs, coat racks, overhead lamps, and rotating side tables to any tubular steel leg, allowing effortless customisation.

<u>Made from</u>	Upholstery over foam on steel frame
<u>Finishes</u>	Upholstered in any fabric 8.5 l/m per chair required 0.9 l/m per cushion required Frame powder coated in any colour
<u>Dimensions</u>	1360h x 720w x 720d Seat 450h
<u>Application</u>	Indoor use
<u>Warranty</u>	10 year commercial warranty
<u>Lead time</u>	Made to order - 8 to 10 weeks
<u>Origin</u>	New Zealand
<u>Designer</u>	Harrows
<u>Certification</u>	Global GreenTagCert™ GreenRate Level C GreenTagPHD™ PlatinumHEALTH™ & HealthRATE™ Declaration™



#### Key Features

- 01  
Acoustic walls
- 02  
Upholstered in fabric of choice
- 03  
3 table top options
- 04  
Method collection extension

# Method



Method Focus, the perfect complement to the Method Seating System. Engineered for productivity, this product boasts integrated power and phone charging alongside seamless cable management. Crafted to adapt to diverse workplace needs, Method Focus offers versatile configurations for quiet workspaces.

<u>Made from</u>	Upholstery over foamed frame with solid worktop
<u>Finishes</u>	3 top options: Solid timber stained in colour of choice, LPL in colour of choice, HPL in black or white Upholstered in any fabric Cable holders powder coated in black as standard
<u>Standard sizes</u>	Method Focus Pod 1080w/1440w x 720d x 1380h Method Focus Alcove 1080w/1440w x 1450d x 1380h
<u>Application</u>	Indoor use
<u>Warranty</u>	10 year commercial warranty
<u>Lead time</u>	Made to order - 8 to 10 weeks
<u>Origin</u>	New Zealand
<u>Designer</u>	Harrows
<u>Certification</u>	Global GreenTagCert™ GreenRate Level C GreenTagPHD™ PlatinumHEALTH™ & HealthRATE™ Declaration™

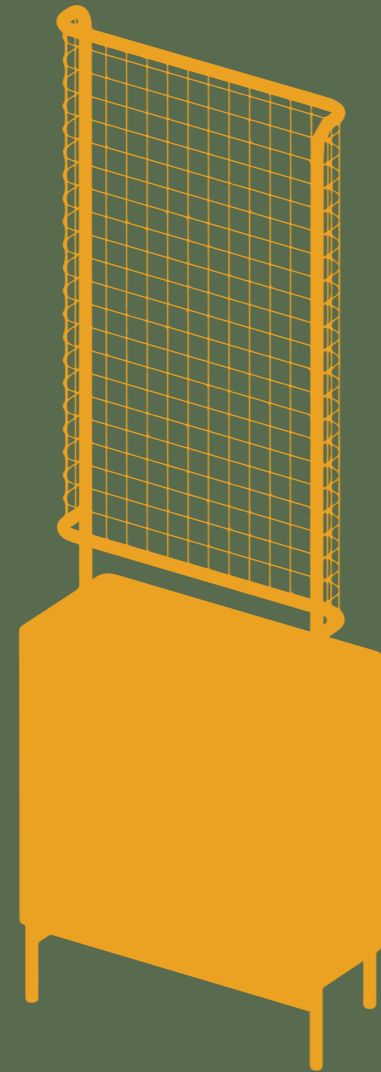

#### Key Features

- 01  
NZ designed, NZ made
- 02  
Powder coat in colour of choice
- 03  
Choice of steel or concrete plant containers
- 04  
Method collection extension

# Method



A modular, freestanding solution designed to divide spaces and introduce biophilic elements into any environment. Available in various sizes and configurations, with options for screens and customisable powder coated steel frames, it seamlessly integrates with the Method Seating System.

<u>Made from</u>	Powder coated steel tube frame
<u>Finishes</u>	Powder coated in any colour
<u>Dimensions</u>	Planter - 720w x 360d x 495h Planter with Screen - 720w x 360d x 1835h High Planter - 720w x 360d x 825h High Planter with Screen - 720w x 360d x 2160h
	Pot Liner - 215ø x 190h
<u>Application</u>	Indoor use
<u>Warranty</u>	10 year commercial warranty
<u>Lead time</u>	Made to order - 8 to 10 weeks
<u>Origin</u>	New Zealand
<u>Designer</u>	Harrows
<u>Certification</u>	Global GreenTagCert™ GreenRate Level C GreenTagPHD™ PlatinumHEALTH™ & HealthRATE™ Declaration™

# Components + Accessories

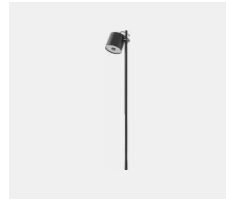

Lamp  
H 1400

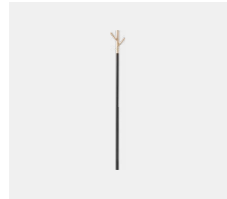

Coat Stand  
H 1400

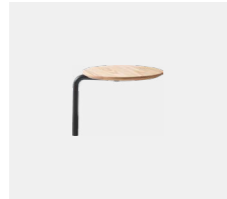

Side Table Round  
Ø 350



Side Table Square  
W 400  
D 300

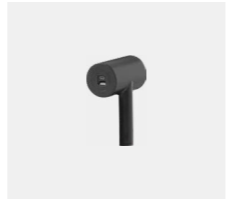

Power  
H 300



Screen Planter  
H 1800  
W 720  
D 360



High Planter  
H 825  
W 720  
D 360



Planter  
H 495  
W 720  
D 360



Concrete Planter  
H 495  
W 720  
D 360



Hard Top Ottoman  
H 450  
W 720  
D 720



Ottoman  
H 450  
W 720  
D 720



Lounge  
H 750/450  
W 720  
D 720



Lounge End  
H 750/450  
W 720  
D 720



Lounge Corner  
H 750/450  
W 720  
D 720



Armchair  
H 750/450  
W 720  
D 720



Highback End  
H 1580/450  
W 720  
D 720



Hushchair  
H 1580/450  
W 720  
D 720

# Suggested Configurations

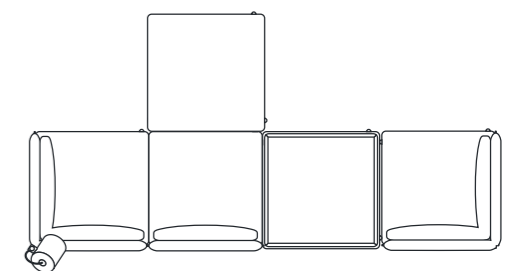
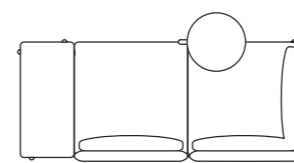
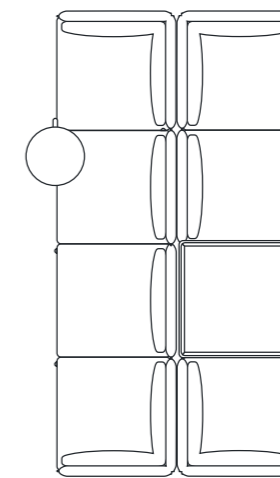
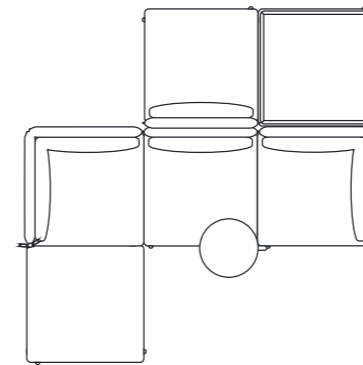
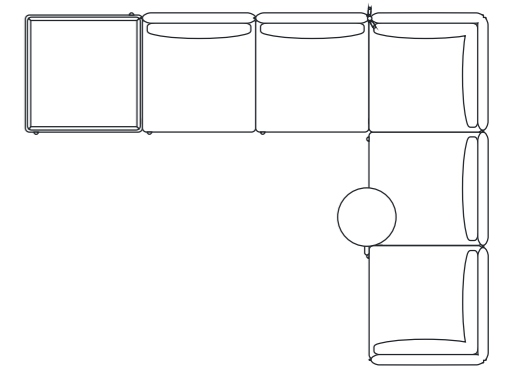
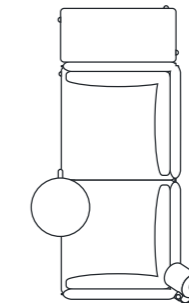
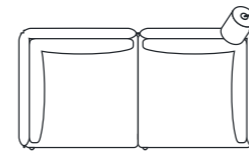
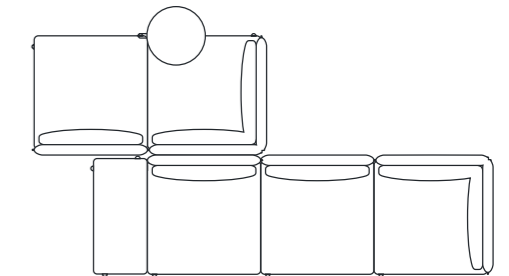
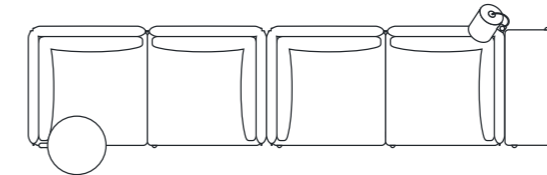
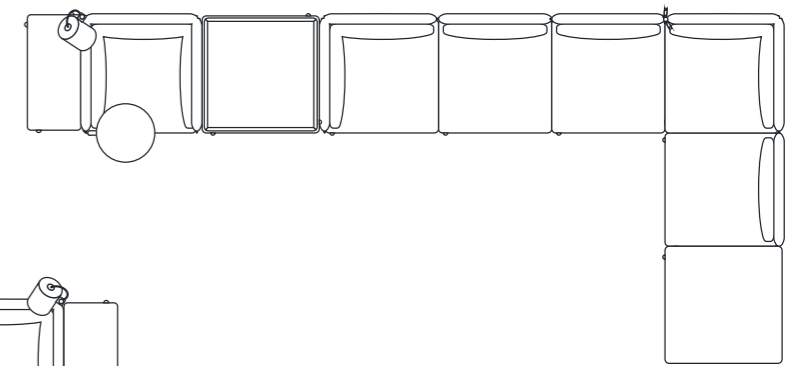
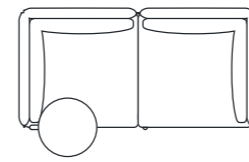

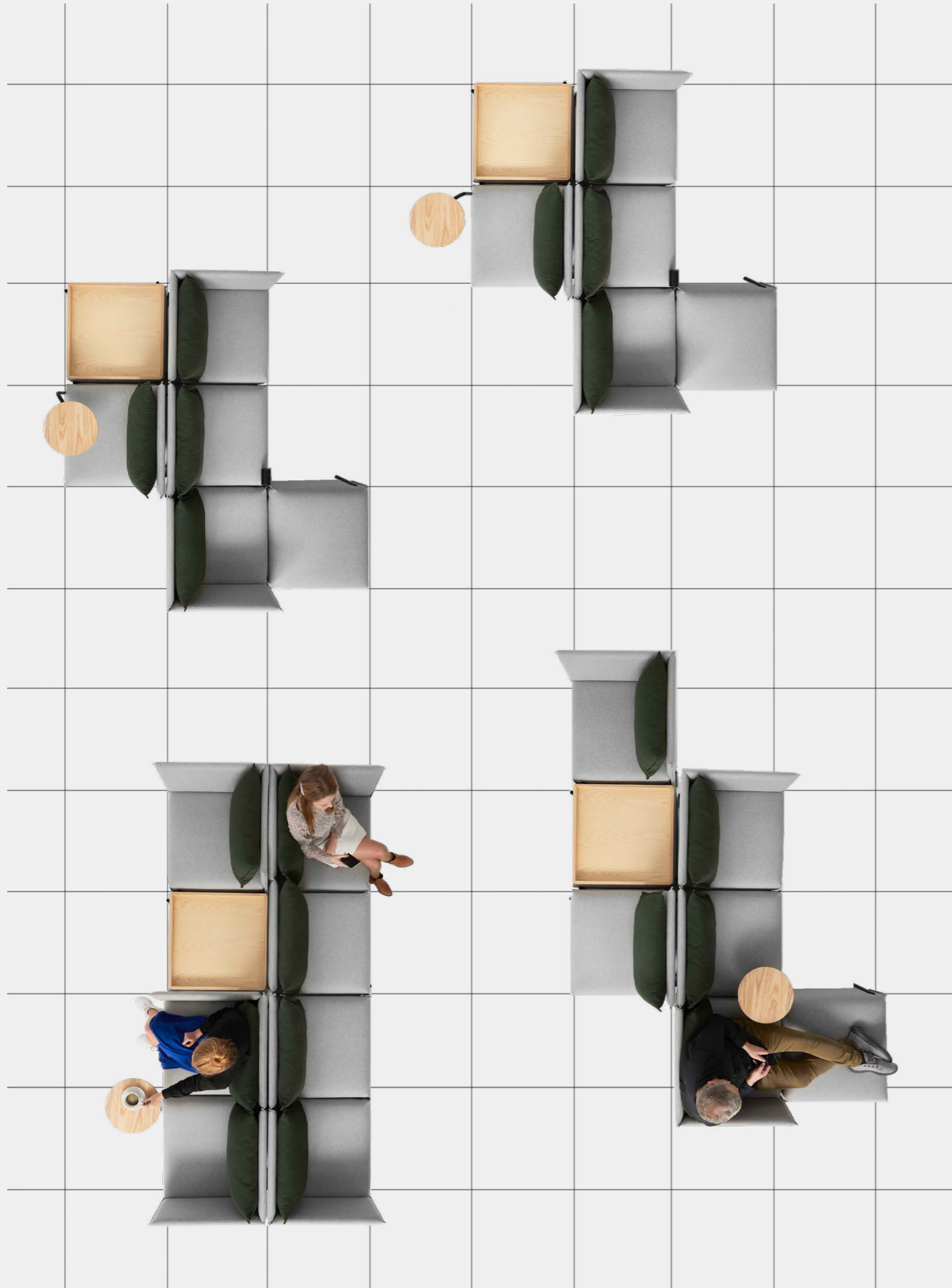

# A flexible floorplan.

Methods modular design and offset leg, each piece effortlessly connects to create limitless configurations, adapting to any space or need.

From collaborative hubs to inviting lounges, Method transforms to fit your vision seamlessly. A full suite of accessories connect to any leg, making customisation and adaptation effortless.

# Made for life.

Method carries GreenRate™ Level C certification and PlatinumHEALTH™ HealthRATE™ certifications under the Global GreenTag International Product Health Declaration™ (GreenTag PHD™) program.

In the Green Star® NZ program Level C carries 50% of the credit points. The GreenTag PHD is recognised by WELL™ and LEED®. A copy of each GreenRate certificate can be downloaded from product resource section.



# About the designer.

“If you’re not going to make it beautiful, don’t bother.”

Mark Suckling, Creative Director.

Mark heads up our inhouse design team and development team, and his guiding philosophy is simple. It must solve a problem. It must endure. And it must be beautiful. To make a product enduring is to make it beautiful.





